

AirRay® Cortical Electrode

Product Catalogue

Electrode for Clinical Diagnostics and Research

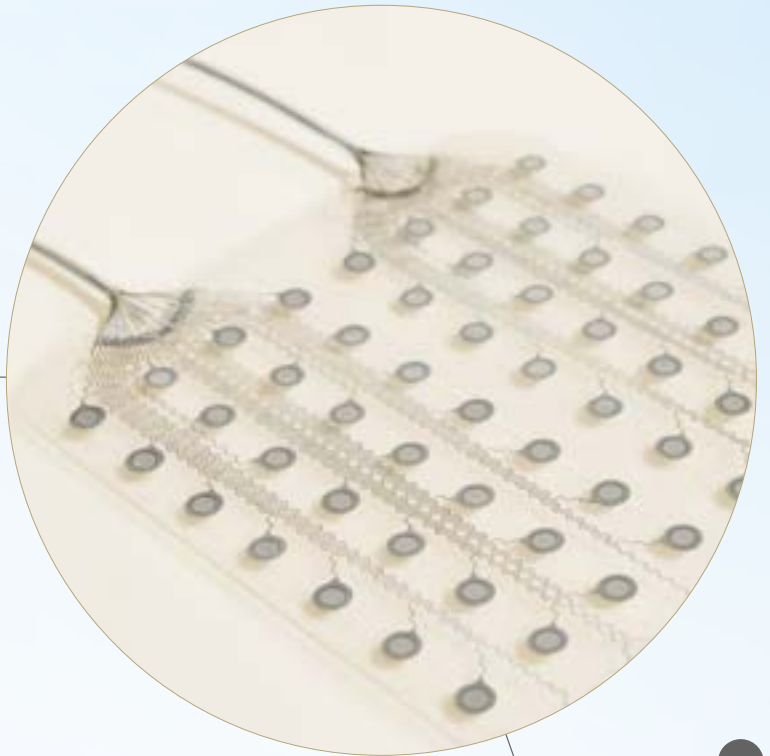



Table of Contents

| °AirRay | Page |
|------------------------------|------|
| > Strip Electrodes | 5 |
| > Grid Electrodes | 8 |
| > Accessory & Services | 18 |
| > Order Information | 22 |



Neuer Messplatz 3
79108 Freiburg | Germany
Fon: +49 761 70 888 222
Fax: +49 761 70 888 399
sales@cortec-neuro.com
www.cortec-neuro.com

Welcome!

°AirRay – High Quality Electrode

°AirRay is our foil electrode for invasive neuromonitoring. It supports brain mapping as well as the monitoring of electrical brain signals, e.g. for the localization of epileptogenic foci for a short implantation period of < 30 days.

Thanks to CorTec's unique laser manufacturing process °AirRay electrodes are very soft, thin, and therefore flexible. Electrodes adapt well to the brain's curvature. °AirRay also provides increased patient safety due to the interlocking structure of its materials that prevents separation of electrode contacts.

CorTec – Thinking ahead

As a young medical engineering company, CorTec focuses on innovations in the fields of neurotherapy and diagnostics.

Thinking ahead, we are developing the neurotechnology of tomorrow already today. On the following pages we would like to introduce you to CorTec's spectrum of °AirRay products.

Please contact us, if you are interested in an electrode configuration that is not in our catalogue.

We are happy to assist you!



° AirRay

Strip & Grid Electrodes

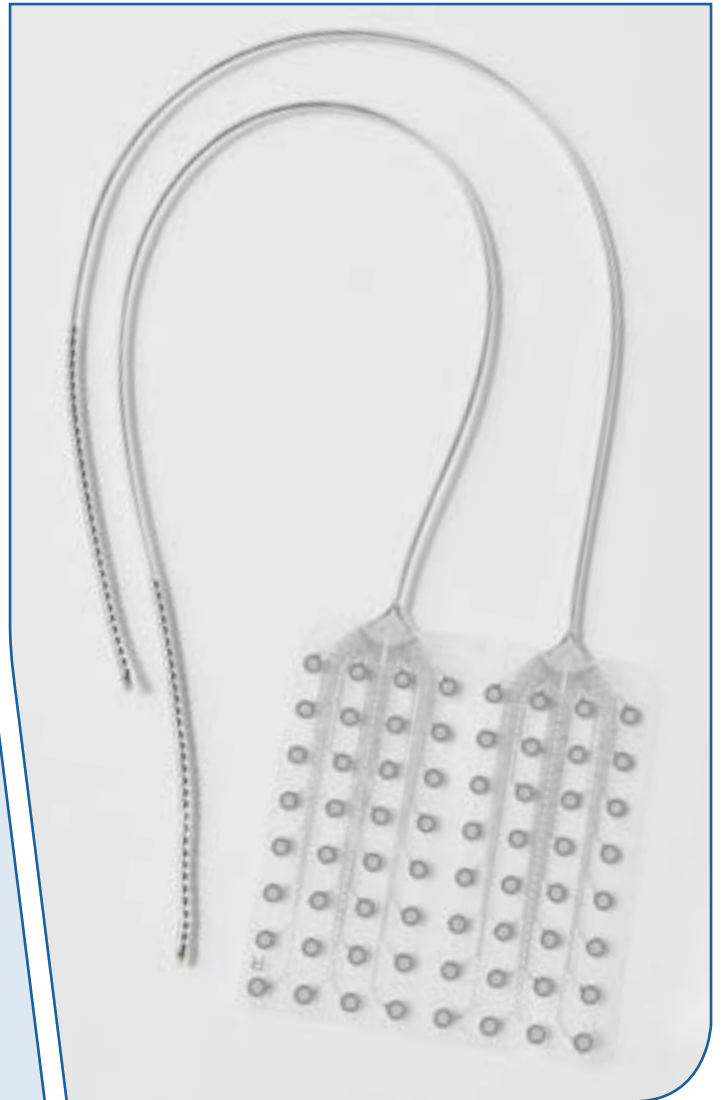



1 x 4 Electrode

The 4-Contact Strip in its classic design. Please contact us for other electrode configurations or designs. Different color codes are available. Cf. p. 22.

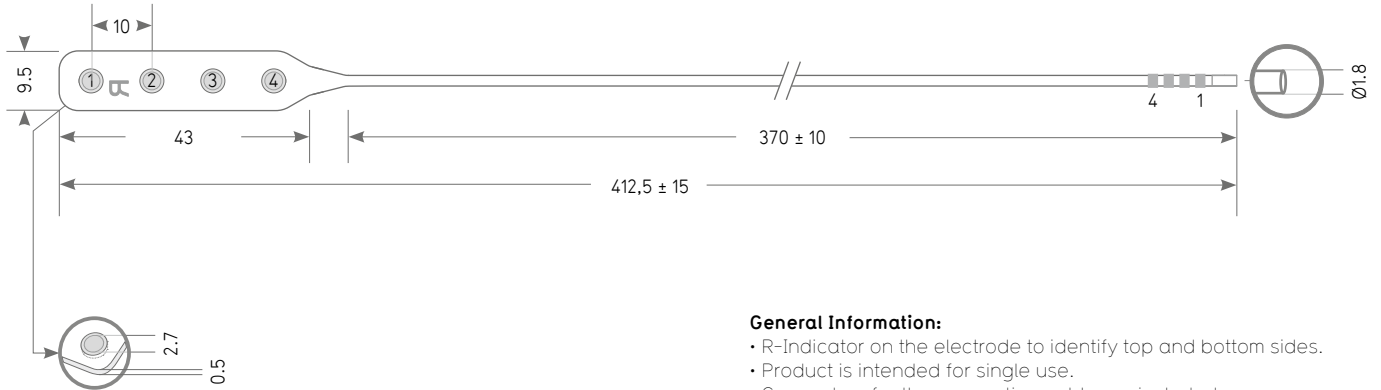

View:
Contact openings
facing upwards

General Information:

- R-Indicator on the electrode to identify top and bottom sides.
- Product is intended for single use.
- Connectors for the connection cable are included.
- Product is supplied sterile.
- Contact diameter is 4 mm in total (contact opening 2.7 mm).
- Learn more about our material properties on page 21.

| Product Configuration | Color Code | Catalogue No. | Accessory Connection Cable | Catalogue No. |
|-----------------------|--------------|---------------|------------------------------|---------------|
| Platinum-Iridium | black-green | 2011.1023.01 | 8 Contacts | 4031.1001.00 |
| | black-orange | 2011.1023.02 | | |
| | individual | 2011.1023.03 | | |

For more information on the connection system please see pages 18ff.

Copyright on all information and drawings is held by **CorTec GmbH** | Drawings represent the product in an abstract way and are not necessarily to scale | **All dimensions in mm** | For pricing please request a quotation.



1 x 6 Electrode

The 6-Contact Strip in its classic design. Please contact us for other electrode configurations or designs. Different color codes are available. Cf. p. 22.

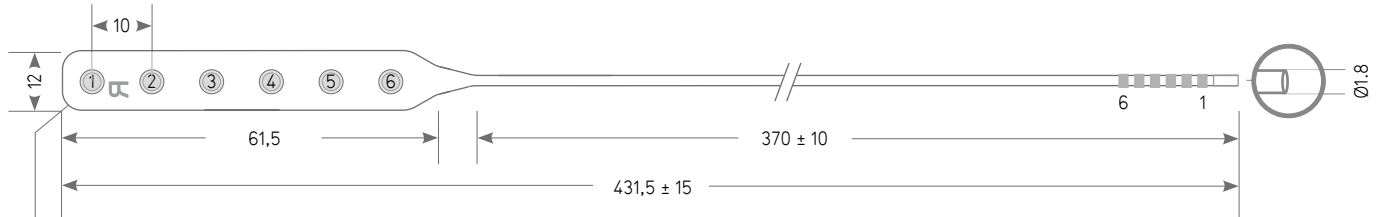

View:
Contact openings
facing upwards

General Information:

- R-Indicator on the electrode to identify top and bottom sides.
- Product is intended for single use.
- Connectors for the connection cable are included.
- Product is supplied sterile.
- Contact diameter is 4 mm in total (contact opening 2.7 mm).
- Learn more about our material properties on page 21.

| Product Configuration | Color Code | Catalogue No. | Accessory Connection Cable | Catalogue No. |
|-----------------------|-------------|---------------|------------------------------|---------------|
| Platinum-Iridium | black-blue | 2011.1022.01 | 8 Contacts | 4031.1001.00 |
| | black-green | 2011.1022.02 | | |
| | individual | 2011.1022.03 | | |

For more information on the connection system please see pages 18ff.

Copyright on all information and drawings is held by **CorTec GmbH** | Drawings represent the product in an abstract way and are not necessarily to scale | **All dimensions in mm** | For pricing please request a quotation.



1 x 8 Electrode

The 8-Contact Strip in its classic design. Please contact us for other electrode configurations or designs. Different color codes are available. Cf. p. 22.

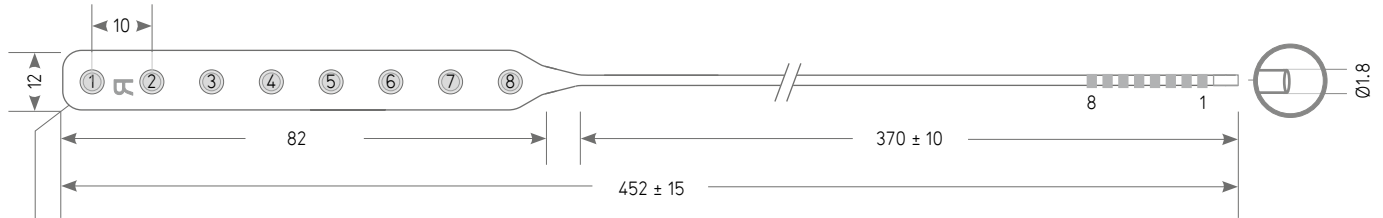

View:
Contact openings
facing upwards

General Information:

- R-Indicator on the electrode to identify top and bottom sides.
- Product is intended for single use.
- Connectors for the connection cable are included.
- Product is supplied sterile.
- Contact diameter is 4 mm in total (contact opening 2.7 mm).
- Learn more about our material properties on page 21.

| Product Configuration | Color Code | Catalogue No. | Accessory Connection Cable | Catalogue No. |
|-----------------------|------------|---------------|------------------------------|---------------|
| Platinum-Iridium | black-red | 2011.1021.01 | 8 Contacts | 4031.1001.00 |
| | black-blue | 2011.1021.02 | | |
| | individual | 2011.1021.03 | | |

For more information on the connection system please see pages 18ff.

Copyright on all information and drawings is held by **CorTec GmbH** | Drawings represent the product in an abstract way and are not necessarily to scale | **All dimensions in mm** | For pricing please request a quotation.



2 x 4 Electrode

Soft and thin structures for increased flexibility and adaptability: 8 contacts. Please contact us for other electrode configurations or designs. Different color codes are available. Cf. p. 22.

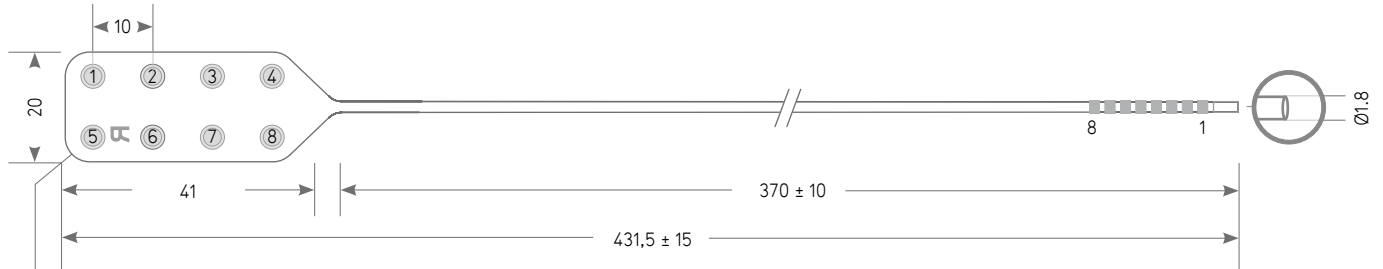

View:
Contact openings
facing upwards

General Information:

- R-Indicator on the electrode to identify top and bottom sides.
- Product is intended for single use.
- Connectors for the connection cable are included.
- Product is supplied sterile.
- Contact diameter is 4 mm in total (contact opening 2.7 mm).
- Learn more about our material properties on page 21.

| Product Configuration | Color Code | Catalogue No. | Accessory Connection Cable | Catalogue No. |
|-----------------------|-------------|---------------|------------------------------|---------------|
| Platinum-Iridium | blue-yellow | 2011.1020.01 | 8 Contacts | 4031.1001.00 |
| | blue-green | 2011.1020.02 | | |
| | individual | 2011.1020.03 | | |

For more information on the connection system please see pages 18ff.

Copyright on all information and drawings is held by **CorTec GmbH** | Drawings represent the product in an abstract way and are not necessarily to scale | **All dimensions in mm** | For pricing please request a quotation.



2 x 5 Electrode

Soft and thin structures for increased flexibility and adaptability: **10 contacts**. Please contact us for other electrode configurations or designs. Different color codes are available. Cf. p. 22.

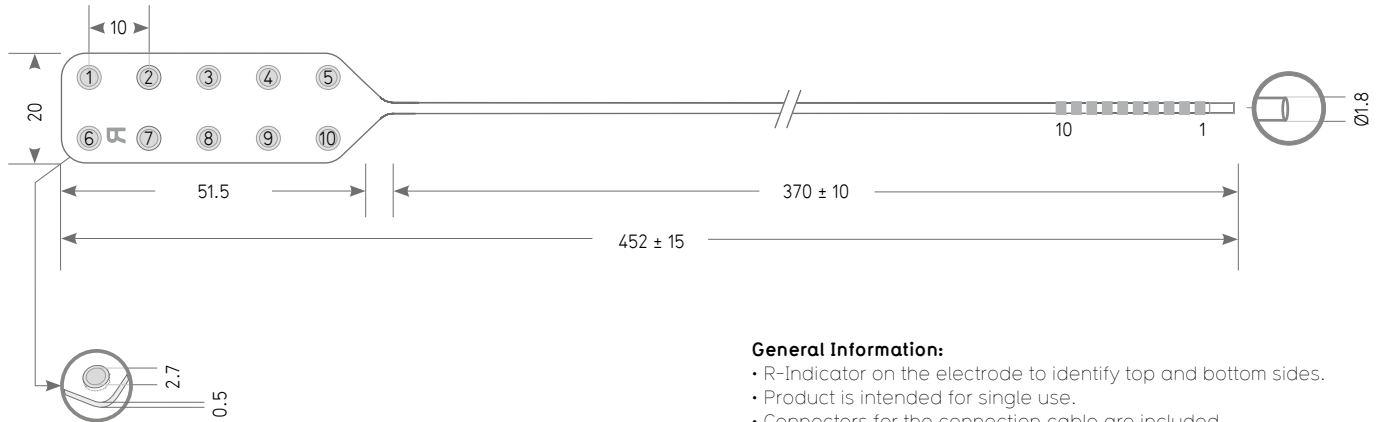

View:
Contact openings
facing upwards

General Information:

- R-Indicator on the electrode to identify top and bottom sides.
- Product is intended for single use.
- Connectors for the connection cable are included.
- Product is supplied sterile.
- Contact diameter is 4 mm in total (contact opening 2.7 mm).
- Learn more about our material properties on page 21.

| Product Configuration | Color Code | Catalogue No. | Accessory Connection Cable | Catalogue No. |
|-----------------------|------------|---------------|------------------------------|---------------|
| Platinum-Iridium | red-blue | 2011.1033.01 | 16 Contacts | 4031.1002.00 |
| | red-yellow | 2011.1033.02 | | |
| | individual | 2011.1033.03 | | |

For more information on the connection system please see pages 18ff.

Copyright on all information and drawings is held by **CorTec GmbH** | Drawings represent the product in an abstract way and are not necessarily to scale | **All dimensions in mm** | For pricing please request a quotation.



2 x 6 Electrode

Soft and thin structures for increased flexibility and adaptability: 12 contacts. Please contact us for other electrode configurations or designs. Different color codes are available. Cf. p. 22.

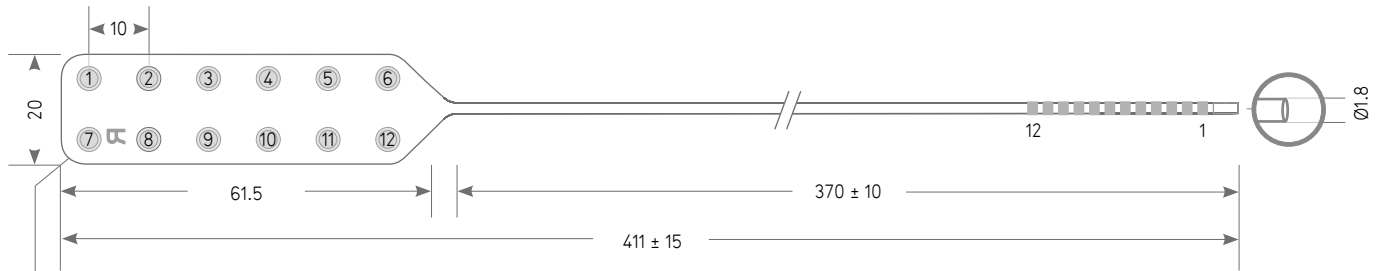

View:

Contact openings facing upwards

General Information:

- R-Indicator on the electrode to identify top and bottom sides.
- Product is intended for single use.
- Connectors for the connection cable are included.
- Product is supplied sterile.
- Contact diameter is 4 mm in total (contact opening 2.7 mm).
- Learn more about our material properties on page 21.

| Product Configuration | Color Code | Catalogue No. | Accessory Connection Cable | Catalogue No. |
|-----------------------|--------------|---------------|------------------------------|---------------|
| Platinum-Iridium | green-yellow | 2011.1035.01 | 16 Contacts | 4031.1002.00 |
| | green-blue | 2011.1035.02 | | |
| | individual | 2011.1035.03 | | |

For more information on the connection system please see pages 18ff.

Copyright on all information and drawings is held by **CorTec GmbH** | Drawings represent the product in an abstract way and are not necessarily to scale | **All dimensions in mm** | For pricing please request a quotation.



2 x 8 Electrode

Soft and thin structures for increased flexibility and adaptability: 16 contacts. Please contact us for other electrode configurations or designs. Different color codes are available. Cf. p. 22.

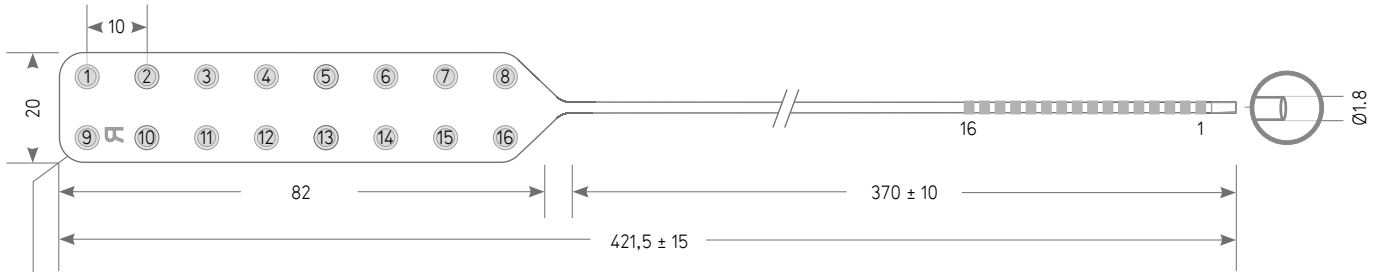

View:
Contact openings
facing upwards

General Information:

- R-Indicator on the electrode to identify top and bottom sides.
- Product is intended for single use.
- Connectors for the connection cable are included.
- Product is supplied sterile.
- Contact diameter is 4 mm in total (contact opening 2.7 mm).
- Learn more about our material properties on page 21.

| Product Configuration | Color Code | Catalogue No. | Accessory Connection Cable | Catalogue No. |
|-----------------------|---------------|---------------|------------------------------|---------------|
| Platinum-Iridium | orange-blue | 2011.1019.01 | 16 Contacts | 4031.1002.00 |
| | orange-yellow | 2011.1019.02 | | |
| | individual | 2011.1019.03 | | |

For more information on the connection system please see pages 18ff.

Copyright on all information and drawings is held by **CorTec GmbH** | Drawings represent the product in an abstract way and are not necessarily to scale | **All dimensions in mm** | For pricing please request a quotation.



4 x 4 Electrode

Soft and thin structures for increased flexibility and adaptability: 16 contacts. Please contact us for other electrode configurations or designs. Different color codes are available. Cf. p. 22.

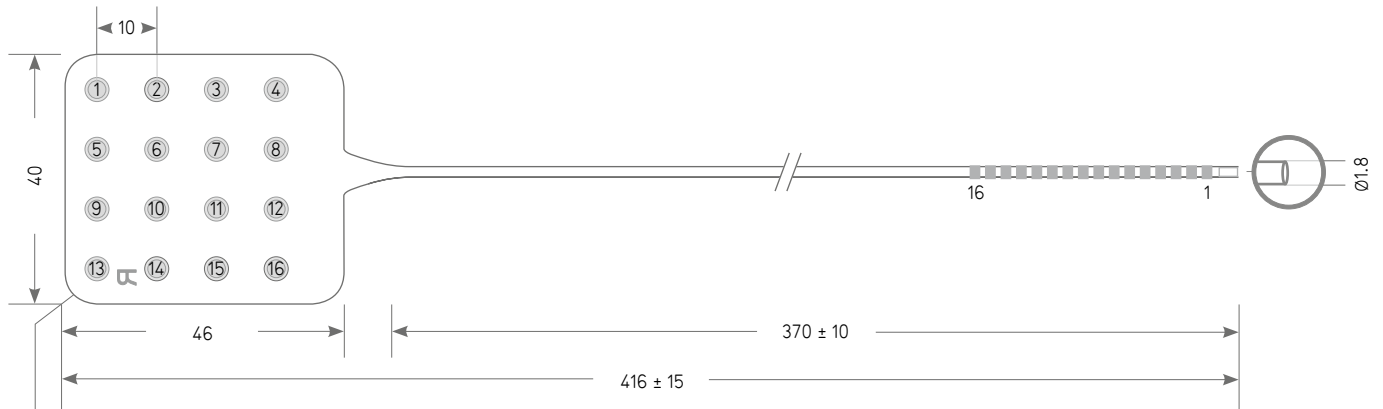

View:
Contact openings
facing upwards

General Information:

- R-Indicator on the electrode to identify top and bottom sides.
- Product is intended for single use.
- Connectors for the connection cable are included.
- Product is supplied sterile.
- Contact diameter is 4 mm in total (contact opening 2.7 mm).
- Learn more about our material properties on page 21.

| Product Configuration | Color Code | Catalogue No. | Accessory Connection Cable | Catalogue No. |
|-----------------------|--------------|---------------|------------------------------|---------------|
| Platinum-Iridium | orange-green | 2011.1018.01 | 16 Contacts | 4031.1002.00 |
| | orange-black | 2011.1018.02 | | |
| | individual | 2011.1018.03 | | |

For more information on the connection system please see pages 18ff.

Copyright on all information and drawings is held by CorTec GmbH | Drawings represent the product in an abstract way and are not necessarily to scale | All dimensions in mm | For pricing please request a quotation.



4 x 5 Electrode

Soft and thin structures for increased flexibility and adaptability: 20 contacts. Please contact us for other electrode configurations or designs. Different color codes are available. Cf. p. 22.

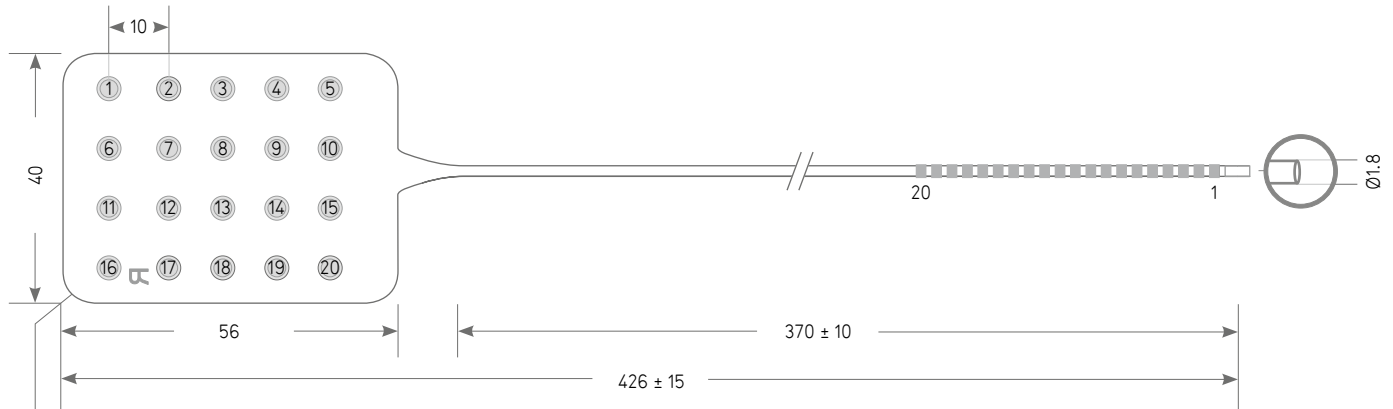

View:
Contact openings
facing upwards

General Information:

- R-Indicator on the electrode to identify top and bottom sides.
- Product is intended for single use.
- Connectors for the connection cable are included.
- Product is supplied sterile.
- Contact diameter is 4 mm in total (contact opening 2.7 mm).
- Learn more about our material properties on page 21.

| Product Configuration | Color Code | Catalogue No. | Accessory Connection Cable | Catalogue No. |
|-----------------------|---------------|---------------|------------------------------|---------------|
| Platinum-Iridium | yellow-black | 2011.1037.01 | 24 Contacts | 4031.1003.00 |
| | yellow-orange | 2011.1037.02 | | |
| | individual | 2011.1037.03 | | |

For more information on the connection system please see pages 18ff.

Copyright on all information and drawings is held by **CorTec GmbH** | Drawings represent the product in an abstract way and are not necessarily to scale | **All dimensions in mm** | For pricing please request a quotation.



4 x 8 Electrode

Soft and thin structures for increased flexibility and adaptability: 32 contacts. Please contact us for other electrode configurations or designs. Different color codes are available. Cf. p. 22.

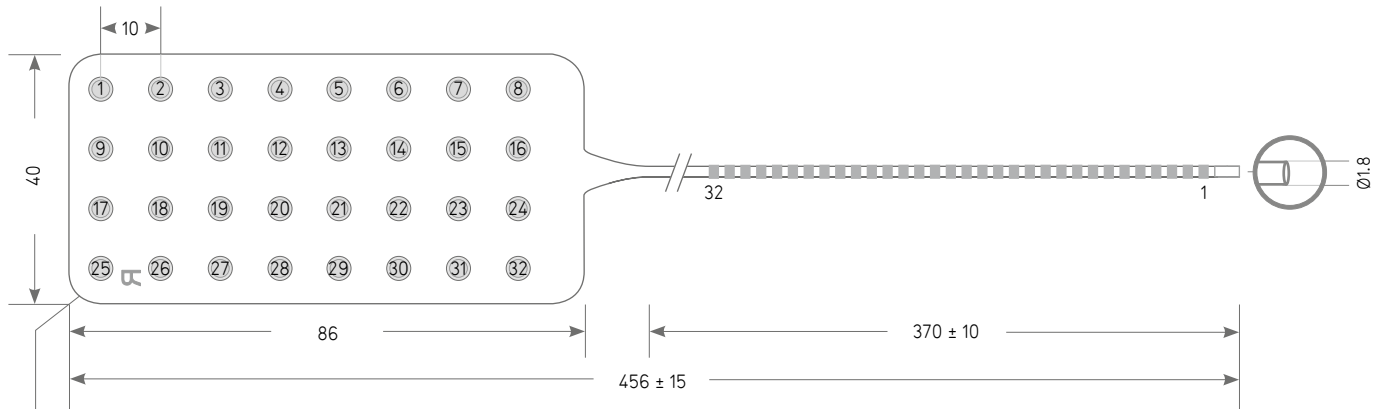

View:

Contact openings facing upwards

General Information:

- R-Indicator on the electrode to identify top and bottom sides.
- Product is intended for single use.
- Connectors for the connection cable are included.
- Product is supplied sterile.
- Contact diameter is 4 mm in total (contact opening 2.7 mm).
- Learn more about our material properties on page 21.

| Product Configuration | Color Code | Catalogue No. | Accessory Connection Cable | Catalogue No. |
|-----------------------|------------|---------------|------------------------------|---------------|
| Platinum-Iridium | red-yellow | 2011.1017.01 | 32 Contacts | 4031.1004.00 |
| | red-black | 2011.1017.02 | | |
| | individual | 2011.1017.03 | | |

For more information on the connection system please see pages 18ff.

Copyright on all information and drawings is held by CorTec GmbH | Drawings represent the product in an abstract way and are not necessarily to scale | All dimensions in mm | For pricing please request a quotation.



6 x 8 Electrode

Soft and thin structures for increased flexibility and adaptability: 48 contacts. Please contact us for other electrode configurations or designs. Different color codes are available. Cf. p. 22.

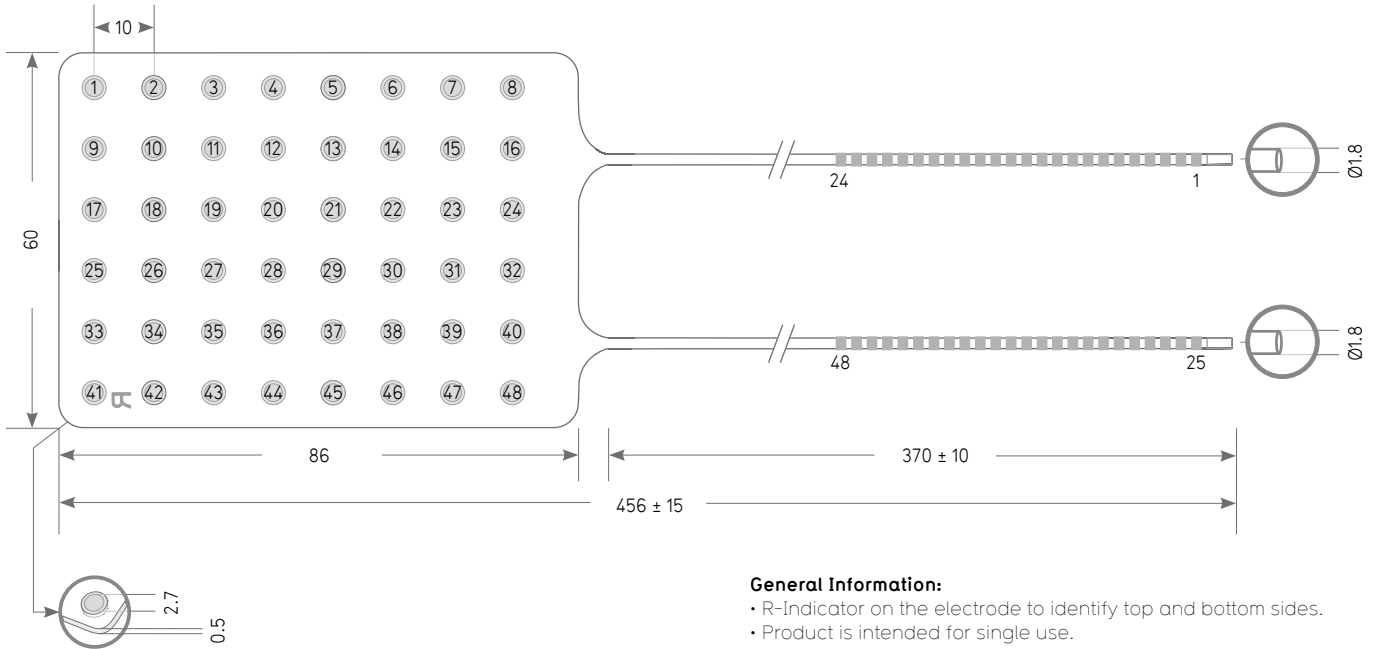

View:

Contact openings facing upwards

General Information:

- R-Indicator on the electrode to identify top and bottom sides.
- Product is intended for single use.
- Connectors for the connection cable are included.
- Product is supplied sterile.
- Contact diameter is 4 mm in total (contact opening 2.7 mm).
- Learn more about our material properties on page 21.

| Product Configuration | Color Code | Catalogue No. | Accessory Connection Cable | Catalogue No. |
|-----------------------|-------------|---------------|------------------------------|---------------|
| Platinum-Iridium | blue-orange | 2011.1039.01 | 24 Contacts (2x) | 4031.1003.00 |
| | blue-green | 2011.1039.02 | | |
| | individual | 2011.1039.03 | | |

For more information on the connection system please see pages 18ff.

Copyright on all information and drawings is held by CorTec GmbH | Drawings represent the product in an abstract way and are not necessarily to scale | All dimensions in mm | For pricing please request a quotation.



8 x 8 Electrode

Soft and thin structures for increased flexibility and adaptability: 64 contacts. Please contact us for other electrode configurations or designs. Different color codes are available. Cf. p. 22.

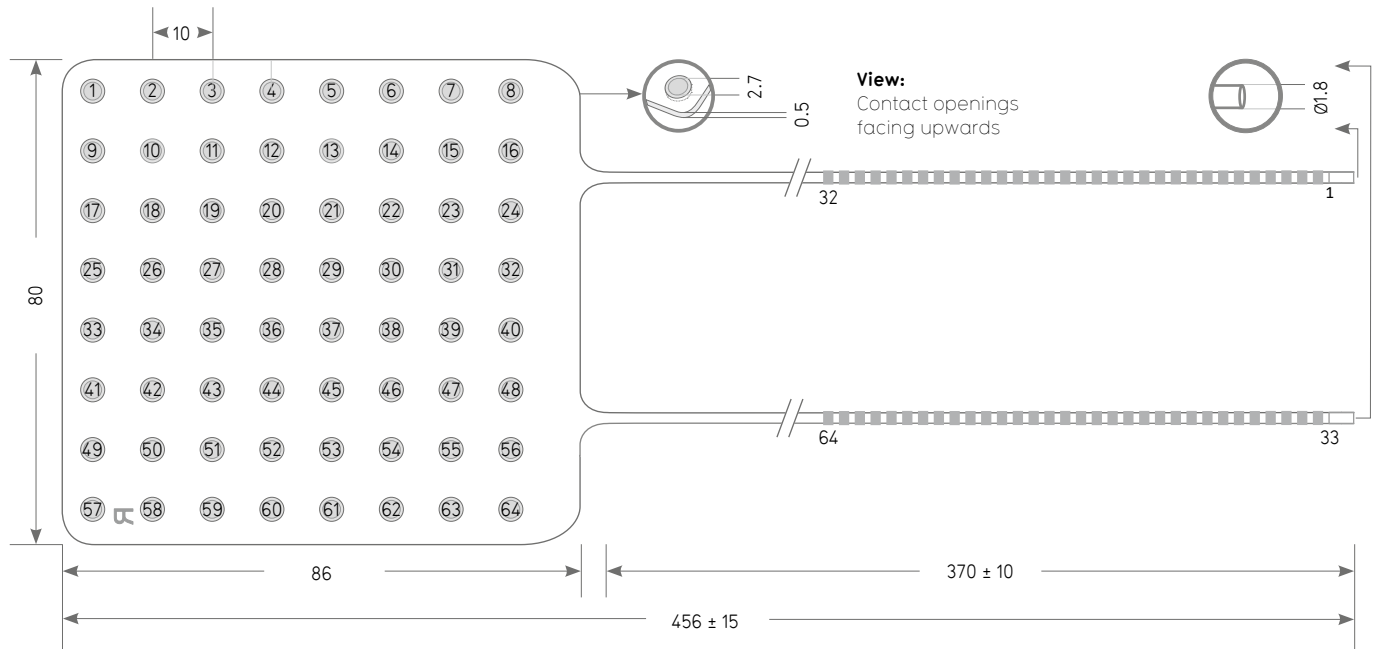

General Information:

- R-Indicator on the electrode to identify top and bottom sides.
- Product is intended for single use.
- Connectors for the connection cable are included.

- Product is supplied sterile.
- Contact diameter is 4 mm in total (contact opening 2.7 mm).
- Learn more about our material properties on page 21.

| Product Configuration | Color Code | Catalogue No. | Accessory Connection Cable | Catalogue No. |
|-----------------------|-------------------|---------------|--|---------------|
| Platinum-Iridium | yellow/red-blue | 2011.1016.01 | 32 Contacts (2x) For more information on the connection system please see pages 18ff. | 4031.1004.00 |
| | blue/green-orange | 2011.1016.02 | | |
| | individual | 2011.1016.03 | | |

Copyright on all information and drawings is held by CorTec GmbH | Drawings represent the product in an abstract way and are not necessarily to scale | All dimensions in mm | For pricing please request a quotation.



Accessory & Services

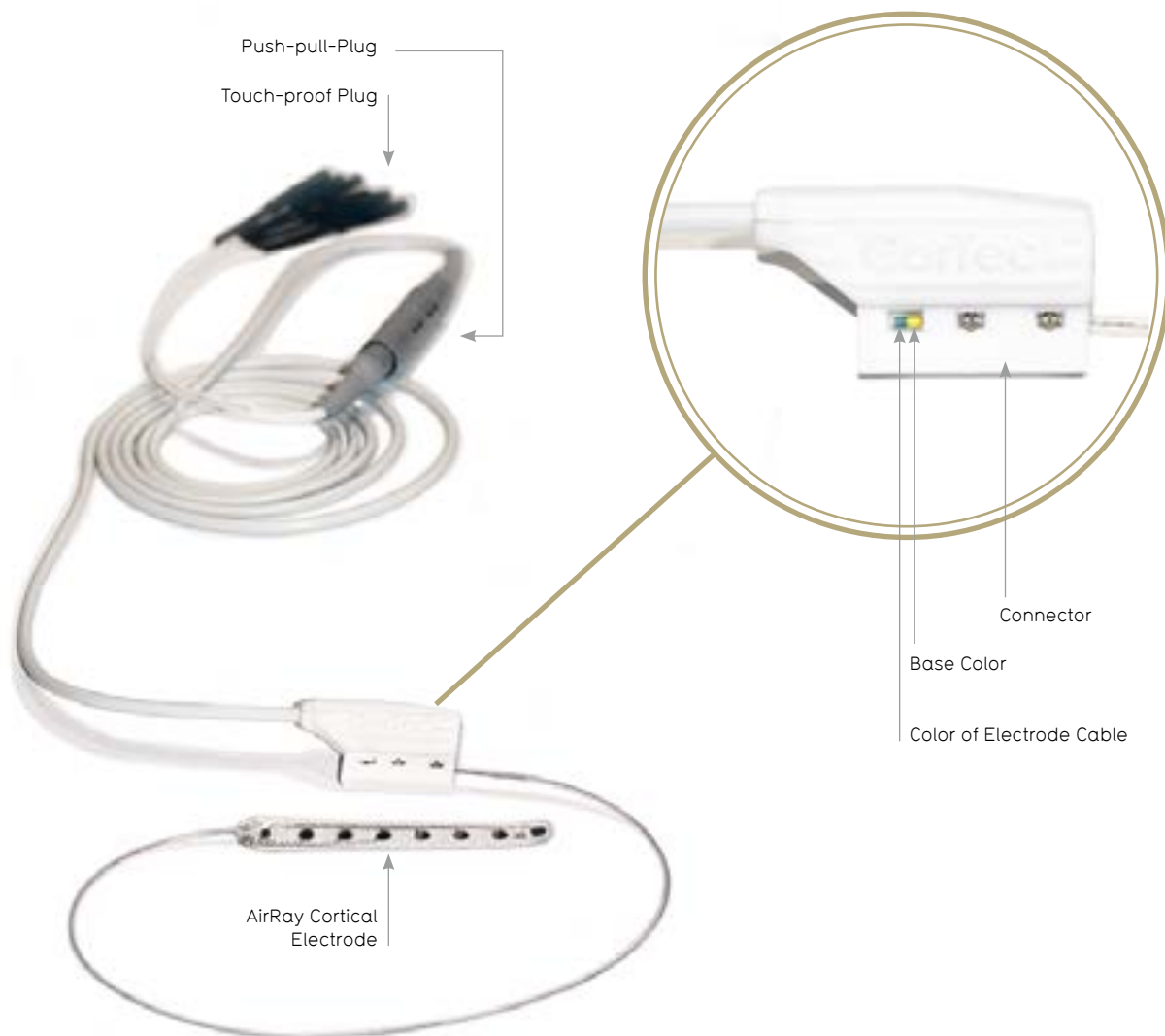



Connection System

Our connection system allows you to connect °AirRay to neuromonitoring systems for recording and stimulation. Connection sizes with 3, 16, 24 and 32 contacts are available.

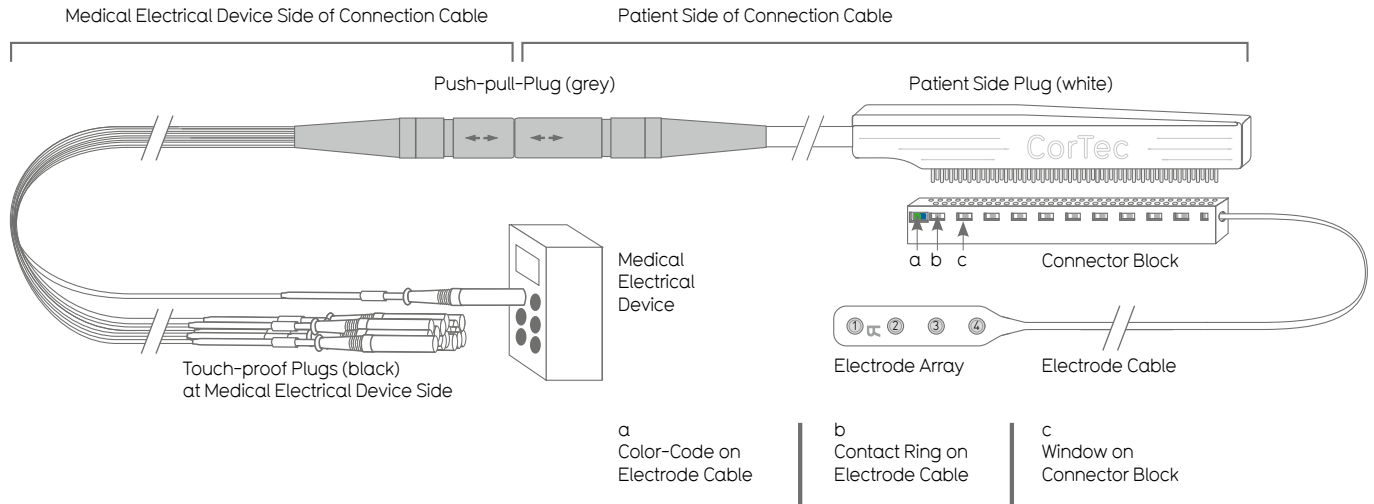

For connecting °AirRay Cortical Electrode to an amplifier or stimulator the electrode cable must be inserted into the connector block until the proximal end reaches the base of the connector block. The color marking must be visible completely through the large window at the closed end of the connector block.

The patient side plug (white) of the connection cable can then be inserted into the connector block. Connectors and plugs each have an additional single pin or an individual plug connection at one

end, which indicates the correct direction for connection. The connector block has to lock into the pins. The connection cable consists of two parts which are connected via a push-pull connector (grey). This simplifies repeated connection and disconnection of the electrode to an amplifier or stimulator.

The touch-proof plugs (black) at the medical electrical device side of the connection cable may remain connected to the amplifier or stimulator and do not need to be reconnected or reassigned for every session.

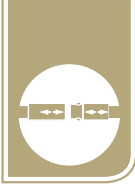

Connection Cable

Connection to the neuromonitoring system. For the connection of the electrode you require one connection cable for each electrode cable. The required sizes and numbers are stated for each electrode as part of the order information.

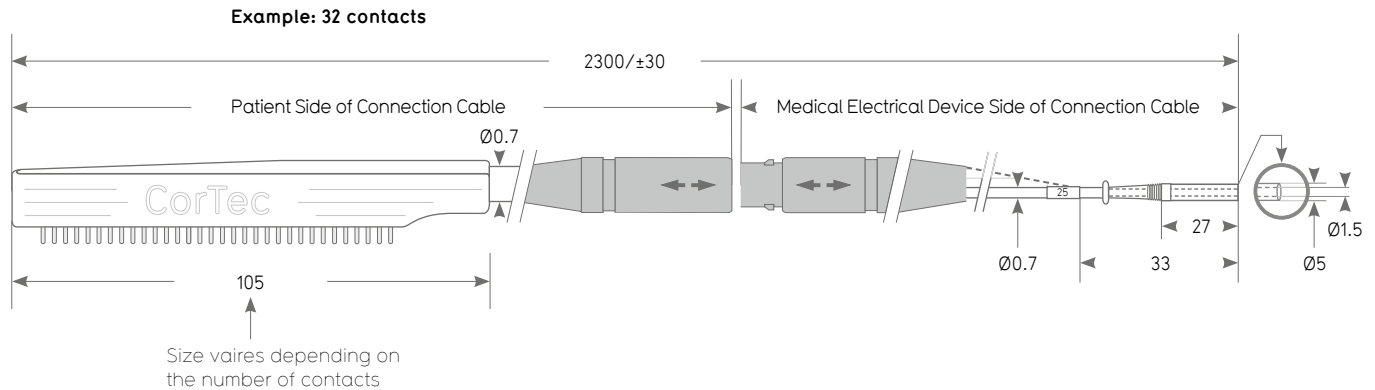

Notes:

- Product is supplied sterile.
- Connectors for the connection cable are included in every electrode shipment.

| Product Configuration | Catalogue No. | Product Configuration | Catalogue No. |
|-----------------------|---------------|-----------------------|---------------|
| 8 Contacts | 4011.1001.00 | 24 Contacts | 4011.1003.00 |
| 16 Contacts | 4011.1002.00 | 32 Contacts | 4011.1004.00 |

Copyright on all information and drawings is held by **CorTec GmbH** | Drawings represent the product in an abstract way and are not necessarily to scale | **All dimensions in mm** | For pricing please request a quotation.

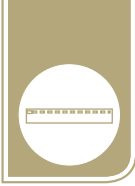

Connector

Connection to the connection cable. Every electrode is shipped with all required connectors included. If you require additional connectors you can order them separately as well.

Example: 32 Contacts

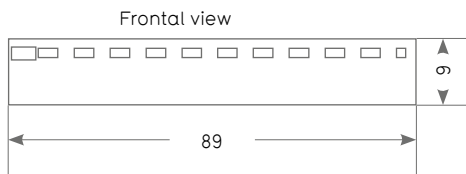
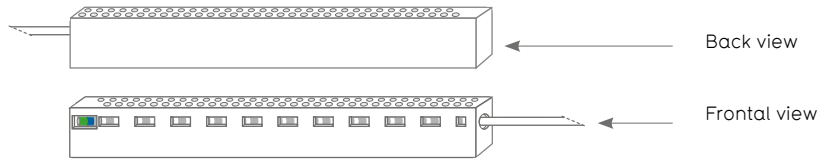

Size varies depending on the number of contacts

Lateral view



Top view

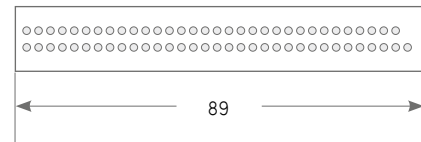

Size varies depending on the number of contacts

| Product Configuration | Catalogue No. | Product Configuration | Catalogue No. |
|-----------------------|---------------|-----------------------|---------------|
| 8 Contacts | 4011.1001.00 | 24 Contacts | 4011.1003.00 |
| 16 Contacts | 4011.1002.00 | 32 Contacts | 4011.1004.00 |

Copyright on all information and drawings is held by **CorTec GmbH** | Drawings represent the product in an abstract way and are not necessarily to scale | **All dimensions in mm** | For pricing please request a quotation.



Materials

All of our electrodes are made using biocompatible materials such as silicone and Platinum-Iridium. The contact material is suitable for both recording and stimulation.

Platinum-Iridium is one of the standard materials commonly used for implants. The addition of Iridium provides the Platinum with additional stability. Platinum-Iridium is especially well suitable for stimulation.

Per default our [®]**AirRay** electrodes have a diameter of 2.7 mm. The following tables provide information on the typical impedances and maximum stimulation parameters of our products:

Impedances (measured in physiological saline)

| Contact Ø 2.7 mm | 1 kHz | 1 kHz |
|------------------|------------|--------------|
| Platinum-Iridium | 60 - 90 kΩ | 0.2 - 0.5 kΩ |

Stimulation Parameters (maximum stimulation):

| Pulse width (ms) | 0.25 | 0.5 | 0.75 | 1.0 | 1.25 | 1.5 | 1.75 | 2.0 |
|------------------|------|------|------|------|------|------|------|------|
| Amplitude (mA) | 24.9 | 12.5 | 8.31 | 6.23 | 4.99 | 4.15 | 3.56 | 3.12 |

Values refer to symmetrical two-phase square pulses (with charge balancing) at a repetition rate of 100 Hz over a one minute period, for contacts with a diameter of 2.7 mm in Platinum-Iridium at 6.23µC/phase/pulse.

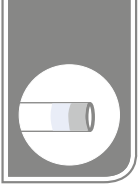

Color-Coding Key

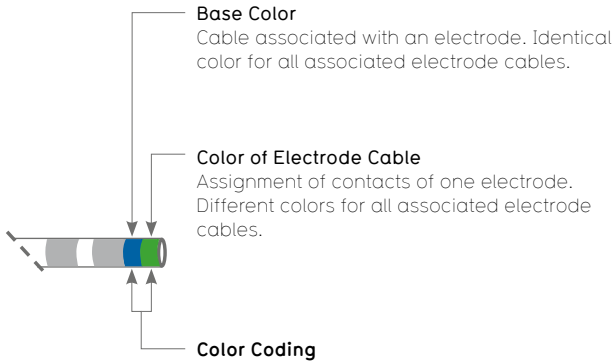

All of our electrodes are supplied with color-coded electrode cables. At the end of the electrode cable there are two color markers that indicate:

- the association of the cable to a specific electrode, as well as
- the assignment of contacts of the same electrode. Color codes are explained in a code chart included in the accompanying documents of a product.

| Color scale | Color Code |
|---|--------------|
|  | YEL yellow |
|  | RED red |
|  | BLU blue |
|  | GRN green |
|  | ORG orange |
|  | BLK black |

If you would like a specific color combination, simply attach the desired color code for the cables of your electrode according to the following example:

- °AirRay 8x8 in Platinum-Iridium, base color green, electrode cables in red and blue.
- Catalogue number „individual“ color code- base color/cable color RED, cable color BLU ...
- 2011.1016.03-GRN/RED, BLU...



Ordering

All products can be ordered by referring to their catalogue number. Please make sure to indicate the color coding of your choice for electrode cables in your order. Please refer to page 22.

Every electrode requires accessories.
Connectors are included with every electrode.
Connection cables have to be ordered separately.

Please refer to page 19.

To submit your order please use the following contact information:

CorTec GmbH

Neuer Messplatz 3
79108 Freiburg | Germany
Fon: +49 761 70 888 222
Fax: +49 761 70 888 399
sales@cortec-neuro.com

Please contact us directly, if you are interested in specific electrode designs not in our catalogue.

We are happy to assist you!

Please also use these contact details to request information on our current prices.





CorTec

Neuer Messplatz 3
79108 Freiburg | Germany
Fon: +49 761 70 888 222
Fax: +49 761 70 888 399
sales@cortec-neuro.com
www.cortec-neuro.com

